

Operating Instructions

M.5.04.09.19



Copyright © 2019 by FORTA® Corporation

FORTA® Corporation

100 Forta Drive

Grove City, PA 16127

1-800-245-0306 or 724-458-5221

Fax: 724-458-8331

Contents

Chapter 1: Overview	3
System description	3
Installation	3
Mobile system	3
Stationary system	4
System basics.....	4
System safety and information labeling.....	6
Product support	7
Contact FORTA® Corporation	7
Chapter 2: Voyager Dispenser	9
Specifications.....	9
Components	10
Chapter 3: Controls and Electronics	13
Electrical disconnect enclosure	13
Main control panel	14
Wireless remote control system	17
Process controls	20
Continuous feed model	20
Display screen.....	21
Function keys.....	22
Set the feed rate	23
Faults/alarms	24
Data storage	25
Accessing the Micro SD card.....	25
Evaluating the data.....	26
Chapter 4: Operation	27
Prepare for operation.....	27
Optimum performance	28
Prime the rake	28
Equipment needed	28
Recommended procedure.....	28

Running a continuous job	31
Filling the drum during a continuous job.....	31
Faults and alarms.....	32
Operating tips.....	32
Troubleshooting	33

Chapter 5: Maintenance **37**

Recommended maintenance schedule	37
Inspect the drum belt	38
Lubricate the rake bearings	38
Inspect the rake coupler insert (spider)	39
Circuit protection.....	39
Reset system after a motor fault.....	39
Rake motor or blower motor fault	39
Drum motor VFD fault	41
Calibrate the system	42
Continuous feed model	42
Recommended procedure	42
Batch feed model	46
Equipment and supplies needed	46
Recommended procedure	46

Chapter 1

Overview

System description

The Voyager bulk fiber dispensing system dispenses synthetic fiber reinforcement into an asphalt or concrete manufacturing process, or other process where synthetic fibers are required. The Voyager system can be installed as a stationary system in a plant or other facility or, if a mobile setup is desired, it can be installed in a fully-enclosed mobile trailer so that it can be moved from site to site. Two drum capacities are available: standard and large. The mobile system is available with the standard drum only.

The Voyager can be purchased with one of two operating options: a continuous feed model or a batch feed model:

- A continuous feed model operates continuously at a user-defined feed rate. It constantly monitors the actual feed rate and makes adjustments to the drum speed as needed to ensure that it matches the set feed rate throughout the job. Continuous feed models are *typically* used in an asphalt manufacturing process, but may also be used in a concrete manufacturing process or other continuous process that requires fiber.
- A batch feed model operates at a fixed feed rate until a user-defined amount of fiber has been dispensed. Batch feed models are *typically* used in a concrete manufacturing process or other batch process that requires fiber.

Installation

Mobile system

If your Voyager bulk fiber dispensing system is in a mobile trailer, the trailer must be at the desired site and the system must be properly and completely setup before the Voyager system can be operated. Refer to the separately supplied [“Quick Guide - Prepare Mobile System for Operation”](#).

In a likewise fashion, when operation of the Voyager is complete at one location and you wish to move it to another location, the mobile system must be properly and completely prepared for transport before it can be moved. Refer to the separately supplied [“Quick Guide - Prepare Mobile System for Transportation”](#). Damage can result if the system is not prepared properly before transport.

Chapter 1: Overview

Stationary system

If your Voyager bulk fiber dispensing system will be used at a processing plant, it must be properly and completely installed at the plant before the Voyager system can be operated. Refer to the separately supplied “Quick Guide - Installation for Fixed Operation”.

System basics

Figure 1 identifies the main components of the Voyager system. Refer to Table 1 for a basic description of each component. For proper operation of the system, it is important to be able to identify these components and understand their basic function.

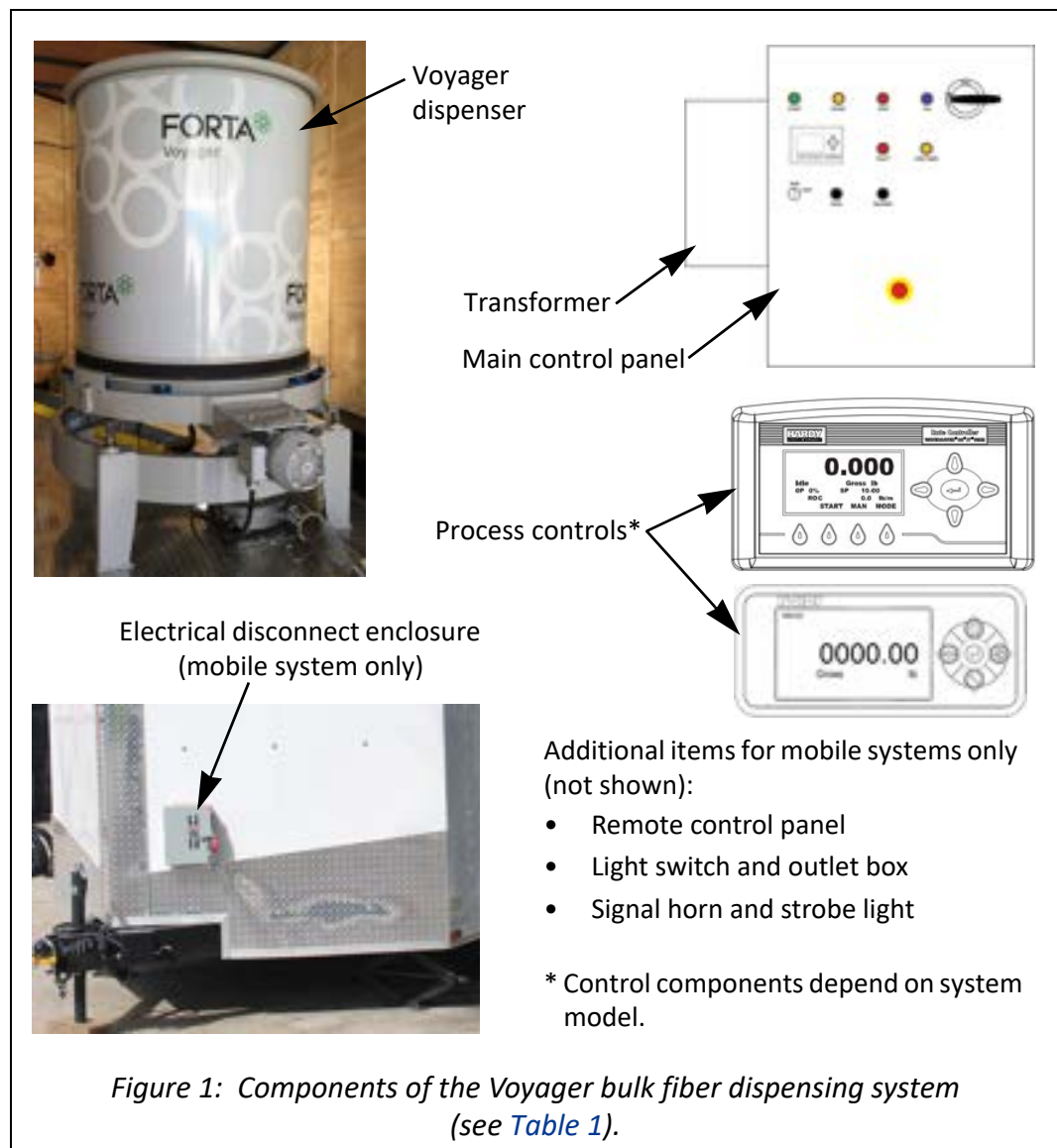

Figure 1: Components of the Voyager bulk fiber dispensing system (see Table 1).







Table 1: Components of the Voyager bulk fiber dispensing system (see Figure 1).

Component	Description
Voyager dispenser:	Dispenses fiber into the asphalt or concrete job at the rate or amount specified by the user through the rate controller. See Chapter 2 for more information.
Main control panel:	Controls operation of the Voyager dispenser. See “ Main control panel ” on page 14 for more information.
Remote control panel:	Optional - mobile systems only. Provides a set of alternate controls for the Voyager system that can be used at a remote location from the mobile trailer. See “ Wireless remote control system ” on page 17 for more information.
Process controls:	The continuous feed or batch feed process is controlled by one or more components. See “ Process controls ” on page 20 for more information; be sure to refer to the correct model for your system - continuous feed or batch feed.
Signal horn and strobe light:	<p>Provided with mobile systems only. The signal horn and strobe light provide an audible and visual indication that the system is in a low fiber condition (see page 15) or has been shutdown due to a fault condition (see page 32). If the horn and light turn on during operation, you should immediately check the system and resolve any issues that caused the horn and light to turn on.</p> <p>The horn and light are located on the outside of the trailer.</p> <p>The horn will sound as follows:</p> <ul style="list-style-type: none"> • 3 beeps and a pause (repeated) for low fiber • Continuous for fault condition
Electrical disconnect enclosure:	Provided with mobile systems only. Provides connection for customer’s power source to the trailer. Refer to “ Electrical disconnect enclosure ” on page 13 for more information.
Light switch and outlet box:	Provided with mobile systems only. The light switch controls lights on the inside of the trailer. The outlets provide a 120 VAC power source.

System safety and information labeling

Table 2 explains the meaning or purpose of any safety and information labels that may be affixed to any part of the Voyager system.

Table 2: Descriptions of safety and information labeling.

Label	Meaning or Purpose
	Rotating parts hazard - Indicates that a hazard exists from rotating parts inside the equipment. Keep hands clear. Use appropriate lock-out/tag-out procedures before servicing equipment.
	Pinch hazard - Indicates that a pinch hazard exists from rollers. Keep hands clear. Use appropriate lock-out/tag-out procedures before servicing equipment.
	Automatic movement hazard - Indicates that the machine moves automatically. Stay clear during operation.
 	Electrical hazard - Indicates that a hazard exists from high voltage or electrical current. Equipment uses a supply voltage of 480 Vac.
	Shock hazard - Indicates that an electrical shock hazard exists. Improper use will result in serious injury or death. Power must be disconnected before servicing equipment - use appropriate lock-out/tag-out procedures. Only authorized/trained personnel should service equipment.
	Caution - Indicates that you should not stand on or place objects (boxes, tools, etc.) on the surface. Doing so could affect the performance of the equipment.

Product support

These instructions outline the proper operation and maintenance of the Voyager bulk fiber dispensing system. If technical assistance is necessary, some assistance is available by telephone consultation with FORTA® Corporation Operations Department. For more in-depth assistance, on-site technical services are available through FORTA® Corporation at a cost of the technician's travel, lodging, and time on site. Contact FORTA® Corporation for details; see [page 7](#).



Important

Failure to follow the within instructions, and any other supplied instructions, may void any applicable warranty.

Contact FORTA® Corporation

If it is necessary to contact FORTA® Corporation, you can do so by the following:

Mail: FORTA® Corporation
100 Forta Drive
Grove City, PA 16127-5221
Phone: 1-800-245-0306 or 1-724-458-5221
Fax: 1-724-458-833
Web: www.fortacorp.com

Chapter 1: Overview

Chapter 2

Voyager Dispenser

Specifications

Specifications of the Voyager are listed in [Table 3](#).

Table 3: Specifications of the Voyager.

	Standard Drum	Large Drum
Feed rate (min/max)	Dependent on type and length of fiber	
Drum capacity by volume	33 ft ³ (0.93 m ³)	53 ft ³ (1.5 m ³)
Drum capacity by weight of fiber (Maximum capacity setting)		
Forta-Fi	315 lb (143 kg)	477 lb (216 kg)
Low fiber alarm level by weight of fiber (LOW FIBER indicator setting, 55% of maximum capacity)		
Forta-Fi	175 lb (80 kg)	260 lb (118 kg)
Low fiber shutdown by weight of fiber (Low fiber shutdown setting, 25% of maximum capacity)		
Forta-Fi	80 lb (36 kg)	120 lb (54 kg)

Components

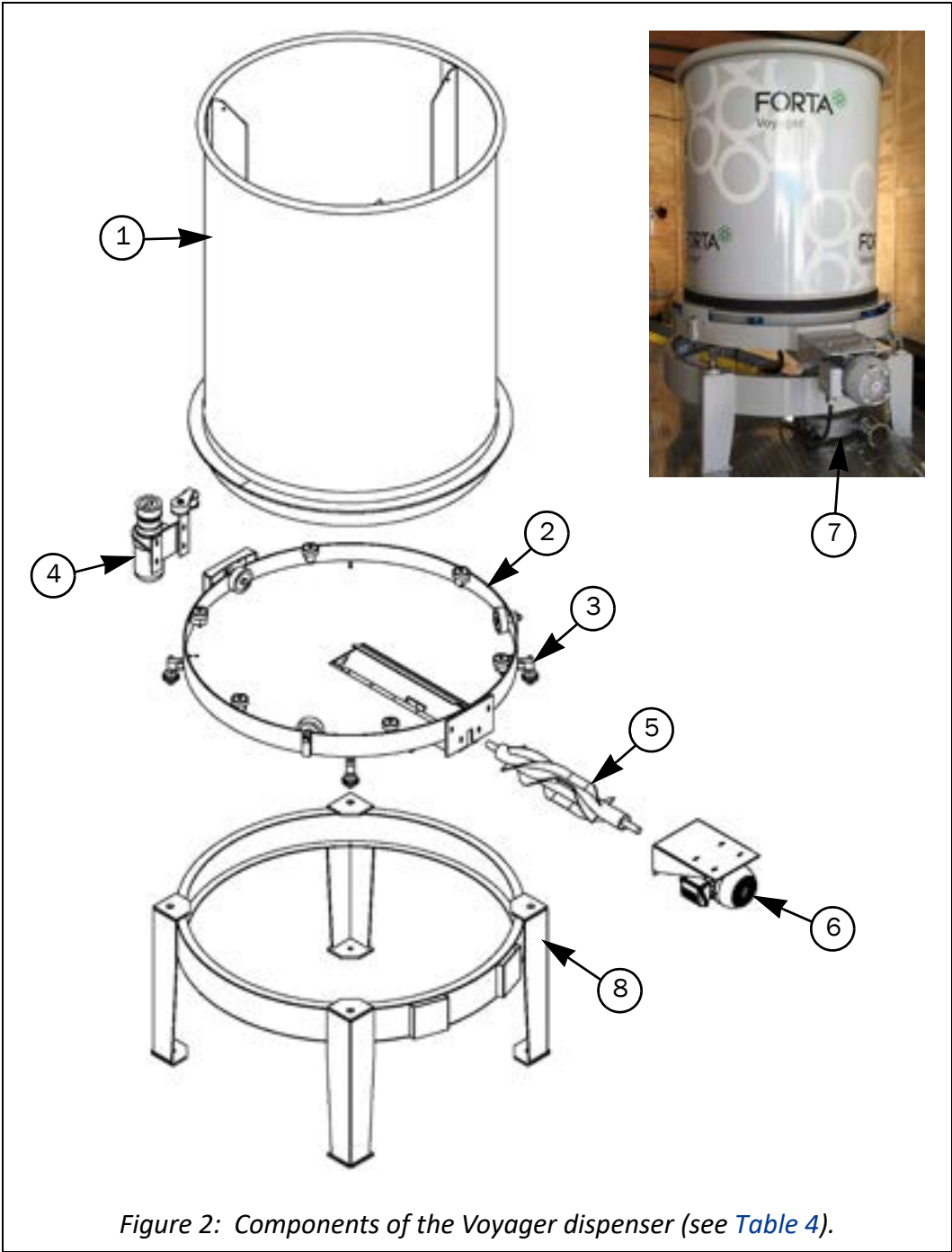



Figure 2: Components of the Voyager dispenser (see Table 4).

Table 4: Components of the Voyager dispenser (see Figure 2).

Component	Description
1. Drum	Holds the fiber to be dispensed. Rotates during operation to move the fibers over the rake.
2. Base	Supports the drum and is equipped with bearings to allow rotation of the drum.
3. Load cells	Detect the weight of the drum and its contents. There are four load cells whose signals are summed to attain total weight. The reading is used to calculate the fiber feed rate and amount of fiber dispensed.
4. Drum motor and drive belt	Rotates the drum so that fiber can be dispensed. The speed of rotation is variable; the faster the drum rotates, the higher the volume of fiber that is dispensed. Drum speed is controlled by the process controls.
5. Rake	Transfers fiber from the drum to the blower.
6. Rake motor and mount	<p>The rake motor rotates the rake at a constant speed.</p> <p> CAUTION! <i>Do not stand on the rake motor mount and do not place objects (i.e. boxes, tools, etc.) on it. The performance of the dispenser may be affected - in particular the performance of the scale.</i></p>
7. Blower	Transfers the fiber through the discharge tubing to the processing location.
8. Stand	Supports the Voyager and provides a solid connection point for the load cells.

Chapter 2: Voyager Dispenser

Chapter 3

Controls and Electronics

Electrical disconnect enclosure

The electrical disconnect enclosure is provided with mobile systems only. It is located on the outside of the trailer and provides connection of power from the customer's power source to the trailer. The service box then feeds power to all the components inside the trailer. The box has a lockable disconnect switch.

For connection information, refer to the separately supplied ["Quick Guide - Prepare Mobile System for Operation"](#)



CAUTION!

The enclosure should never be opened except to connect/disconnect power. Keep the door closed and locked at all other times. DO NOT use the enclosure for storage!



Figure 3: The electrical disconnect enclosure.

Main control panel

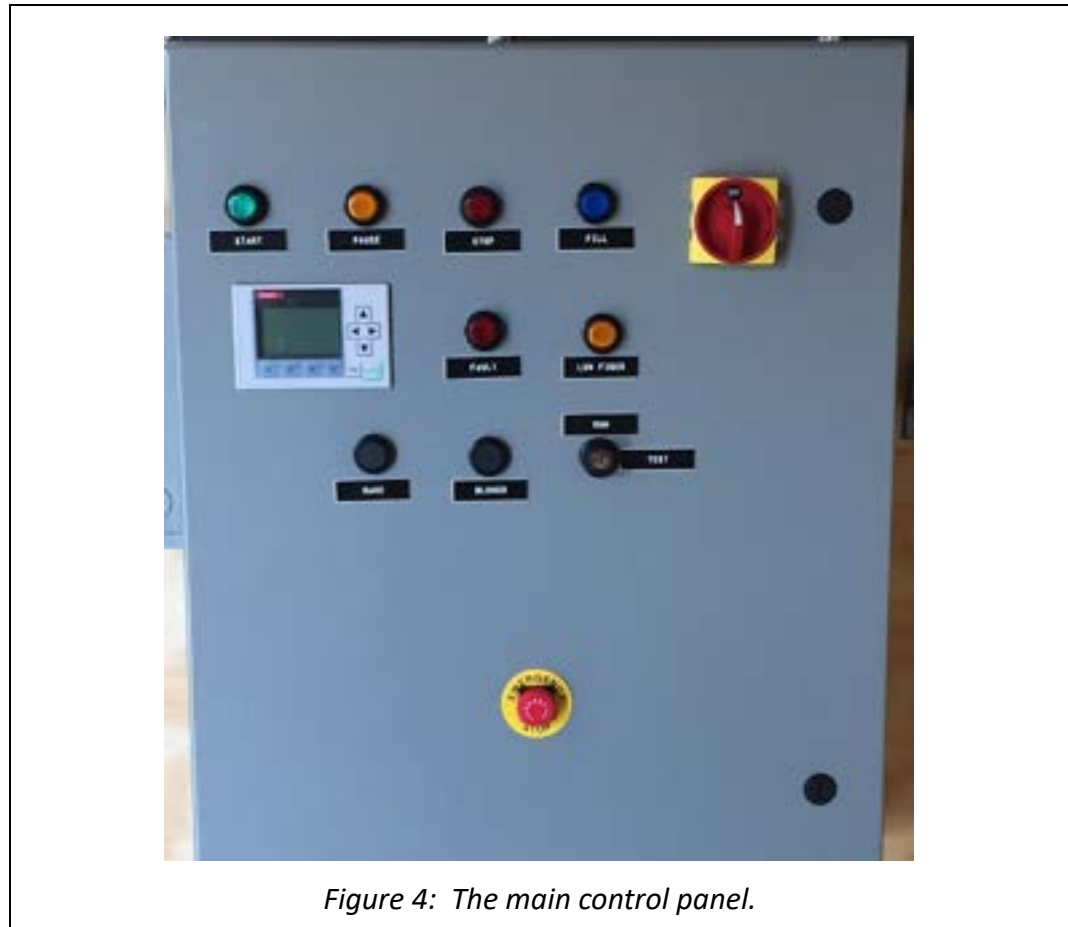

Figure 4: The main control panel.



CAUTION!

The main control panel should never be opened except for service or to retrieve the micro SD card. The transformer box on the side of the main control panel should never be opened except for service. Keep both doors closed and locked at all other times. **DO NOT** use the panel or the box for storage!

Table 5: Controls located on the main control panel.

Control	Description
EMERGENCY STOP button:	Press to stop all operation of the system. The signal horn puts out a continuous beep sound and the strobe light turns on. Should only be used for an emergency stop of the system. For normal shutdown of the system use the STOP button. To release the EMERGENCY STOP button, turn it clockwise as depicted by the arrows on the knob face; the button should then pop out.

Table 5: Controls located on the main control panel. (Continued)

Control	Description
Disconnect switch:	Controls power to the main control panel.
START button and indicator:	Press to start a fiber dispensing job. The dispenser will go through the following startup sequence: the blower immediately turns on, and then 5 seconds later the drum and rake turn on to feed fibers to the blower. At this point the rate controller takes over control of the system. The START button illuminates once the drum and rake motors turn on.
PAUSE button and indicator:	Press to put Voyager into PAUSE mode. When in PAUSE mode the rotation of the drum and rake stop which stops feeding fibers to the blower. The blower continues to operate. Both the PAUSE and STOP buttons illuminate to indicate that the system is in PAUSE mode. The PAUSE mode would be used, for example, if the asphalt drum needs to stop for a short time. To resume operation of the job, press the START button.
STOP button and indicator:	Press to stop all operation of the dispenser. The STOP button illuminates. This button should be used for normal shutdown of the system upon completion of a fiber dispensing job. The blower will continue to run for 5 seconds after the STOP button is pressed.
FILL button and indicator:	Press to put system into FILL mode. Both the FILL and STOP buttons illuminate to indicate that the system is in FILL mode. The rate controller switches from running the system in rate control to running at a fixed speed and shows a status of <i>Refill</i> . Refer to “ Filling the drum during a continuous job ” on page 31 for the recommended procedure.
FAULT indicator:	Illuminates when the system is in a fault condition; see “ Faults and alarms ” on page 32.
LOW FIBER indicator:	Illuminates when the amount of fiber in the drum has reached the low fiber level as set in the rate controller (about 55% of drum capacity, see Table 3 on page 9). In addition, the signal horn and light will activate to give external audible and visual signals that the low fiber level has been reached and the drum needs filled. If the drum is not filled, the Voyager will continue to operate in LOW FIBER mode until the amount of fiber in the drum has reached the low fiber shutdown level (about 25% of drum capacity, see Table 3 on page 9), at which point the system will shutdown.
RAKE button:	Used only in TEST mode to check the direction of rotation of the rake motor. This is a momentary contact type button and will only run the rake motor when depressed.
BLOWER button:	Used only in TEST mode to clear the blower of fibers. This is a momentary contact type button and will only run the blower motor when depressed.

Chapter 3: Controls and Electronics

Table 5: Controls located on the main control panel. (Continued)

Control	Description
RUN/TEST key switch:	Puts system in either RUN mode or TEST mode. RUN mode is for normal operation of the system. TEST mode should only be used during setup of the trailer or during maintenance when indicated in instructions; refer to the separately supplied “Quick Guide - Prepare Mobile System for Operation” . The key for the switch should be located inside the main control panel.
Fault Display:	Indicates any system faults. To illuminate the screen (turn on backlight), press the ESC button on the fault display. During normal operation, the fault display screen will indicate NO FAULTS . There are 6 different fault conditions that will cause the Voyager to shutdown; see “Faults and alarms” on page 32.

Wireless remote control system

A wireless remote control system is provided with mobile systems only. It provides basic control of the Voyager system from a remote location (up to 2 miles with clear line of sight). The system consists of a transceiver box that resides in the trailer and a remote control panel that can be placed where the main process controls are located. The controls on the remote panel consist of start and stop indication and control, fault/low fiber detection, and rate monitoring and control. Refer to [Figure 5](#) and [Table 6](#) for descriptions of the controls on the panel.



CAUTION!

Never unplug the remote control panel while the Voyager is in operation.



CAUTION!

DO NOT pick up or hold the remote control panel by its antenna. The antenna is NOT designed to support the weight of the box. Any damage incurred by picking up or holding the remote control panel by its antenna is not covered under warranty.



CAUTION!

The remote control panel and the transceiver box should never be opened except for service. Keep the doors closed and locked at all other times. DO NOT use either the panel or the box for storage!

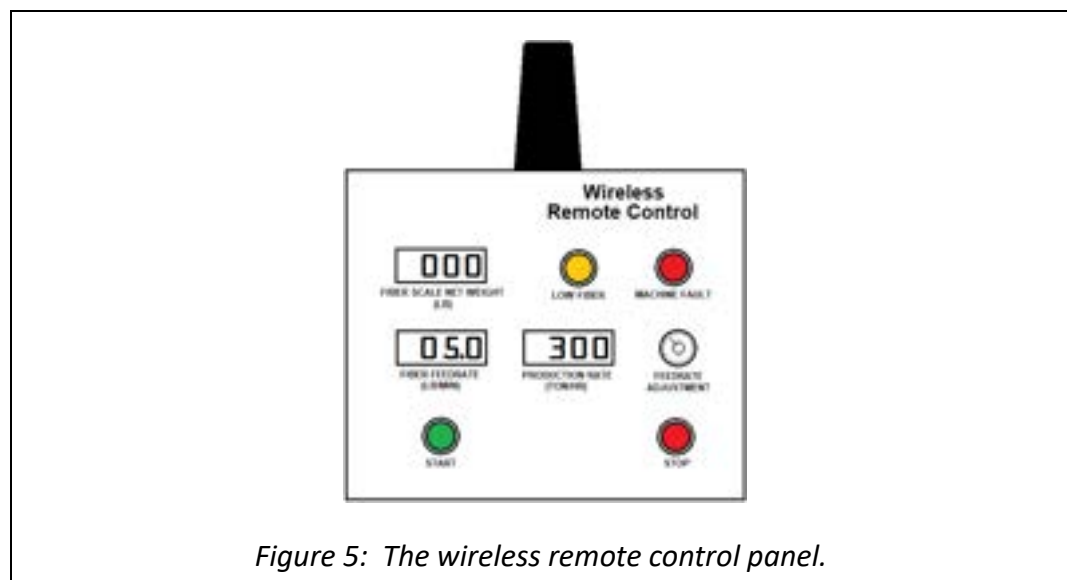

Figure 5: The wireless remote control panel.

Chapter 3: Controls and Electronics

Table 6: Controls on the remote control panel.



Control	Description
FIBER SCALE NET WEIGHT display:	Displays the current net weight of fibers in the drum.
LOW FIBER indicator:	This indicator functions the same as its counterpart on the main control panel; see Table 5 .
MACHINE FAULT indicator:	This indicator functions the same as the FAULT indicator on the main control panel; see Table 5 .
FIBER FEEDRATE display:	Displays the current feed rate of fiber from the Voyager in lb/min.
PRODUCTION RATE display:	<p>Displays the equivalent production rate, in tons/hr, of product (asphalt, concrete, etc.) needed from the plant in order to maintain the correct dosage of fiber at the current feed rate.</p> <p>For FORTA-FI fiber, this would be 1 lb of fiber per ton of asphalt.</p> <p>For example, if the feed rate of the Voyager is set to 5.0 lb/min, then the production rate of the plant would need to be 300 ton/hour in order to result in a FORTA-FI dosage of 1 lb/ton (5.0 lb/min x 60 min/hr = 300 lb/hr which equates to 300 ton/hr of asphalt).</p> <p> Note <i>This display is NOT tied into the actual plant production - it does NOT indicate the actual rate of the plant. If the plant's production rate is changed, then the Voyager's feed rate must be adjusted to maintain the correct dosage of fiber at the new production rate.</i></p>
FEEDRATE ADJUSTMENT potentiometer:	<p>Adjust the potentiometer to set or change the feed rate of fiber. The feed rate should be set before a job is started.</p> <p> Note <i>The numbers/markings on the dial of the potentiometer are not relative and should not be used to select feed rate.</i></p>

Table 6: Controls on the remote control panel. (Continued)

Control	Description
<p>START button and indicator:</p>	<p>This button and indicator functions the same as its counterpart on the main control panel (see Table 5), except that the indicator will illuminate immediately upon pressing the button instead of waiting until the drum and rake motors start. The indicator will remain on throughout the run until the STOP button is pressed and the blower has come to a complete stop. Thus there is a period of overlap during system shut down when both the STOP and START indicators are illuminated. This period of overlap is approximately 6 seconds - the time that it takes the blower to physically stop.</p>
<p>STOP button and indicator:</p>	<p>This button and indicator functions the same as its counterpart on the main control panel; see Table 5. Once pressed, ensure that the indicator has illuminated. Shutdown of the Voyager is instantaneous. The START indicator will remain illuminated until the blower has come to a complete stop - this creates a period of overlap during system shut down when both the STOP and START indicators are illuminated. This period of overlap is approximately 6 seconds - the time that it takes the blower to physically stop.</p>

Process controls

The continuous feed or batch feed process of the Voyager is controlled by process controls. The model, functionality and operation of the process controls vary depending on whether the Voyager system is a continuous feed or batch feed model. Be sure to refer to the appropriate section below for your setup.

Continuous feed model

When the Voyager is provided as a continuous feed model, the continuous feed process is controlled by a rate controller (see [Figure 6](#)). The rate controller is configured as a single-ingredient, loss-in-weight rate controller that controls and measures the feed rate of the Voyager. The user sets the desired feed rate (denoted as setpoint (SP) on rate controller), and an algorithm automatically calculates and adjusts the tuning parameters needed to maintain that rate during a job. After comparing the actual feed rate (measured by calculating the loss of weight over short intervals) to the desired feed rate, it computes the adjustments needed to achieve the desired rate and transmits signals to adjust the speed of the drum.



CAUTION!

The controller should never be opened except for service by qualified personnel. Keep the box closed and locked at all other times. DO NOT use the box for storage!



Note

Even with a completely empty drum, the rate controller might not show zero gross weight on the display (GROSS). This is most likely due to local setup conditions and does not affect the accuracy of the system since it operates on a lose-in-weight basis. Do not attempt to zero the weight display - this will negate the calibration.

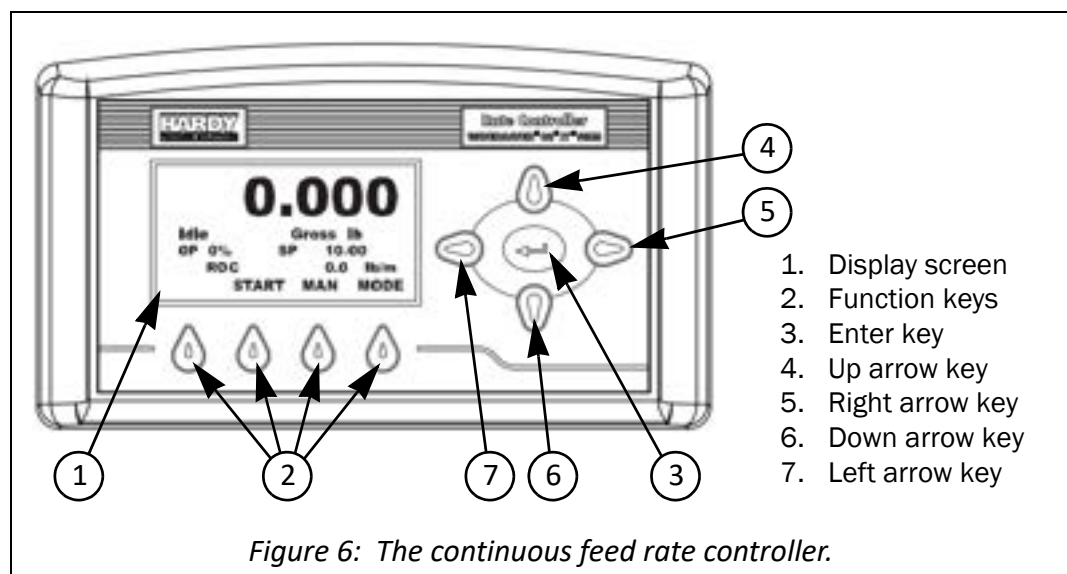

Display screen

For ease of discussion, the display screen can be broken down into the following areas (see [Figure 7](#)):

- **Summary area** – displays one of four selectable values or a fault/alarm condition in large print, which allows the operator to check system performance at a glance. You can toggle through the selectable values by pressing the **MODE** function key. For more information on system fault/alarm conditions, see “[Faults and alarms](#)” on [page 32](#).
 - ✦ **GROSS** – displays the gross weight of fiber currently in the drum.



Note

Even with a completely empty drum, the rate controller may not show zero gross weight; it should typically read within +/-2 lb of zero. Do not attempt to zero the weight display - this will negate the calibration.

- ✦ **ACT** – displays the actual feed rate in units of weight/time. This is an averaged rate of change (ROC) and is the best indication of your current feed rate and system performance.
- ✦ **TOTAL** – displays a running total of fiber by weight that has run through the Voyager. This reading is not resettable.
- ✦ **AMT** – displays the amount of fiber by weight that has been processed through the Voyager since the last start. The counter runs from the time you press the **START** button until you press the **STOP** button.

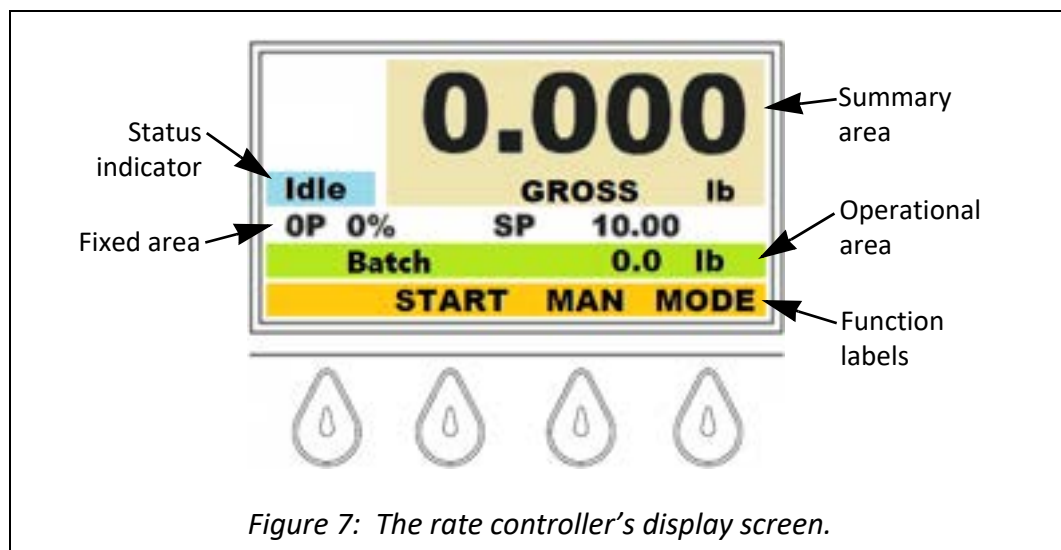

Figure 7: The rate controller's display screen.

- **Operational area** – displays one of six selectable values. You can toggle through the values by pressing the **Up arrow** and **Down arrow** keys (4 and 6, [Figure 6](#) on [page 20](#)).
 - ✦ **Ingredient** – displays the current selected ingredient.

Chapter 3: Controls and Electronics

- ✦ **ROC** (Rate of Change) – displays the change rate in units of weight/time. ROC is the raw, unaveraged feed rate for visualization of your flow rate and is not the best indication of overall performance.
- ✦ **Total** – displays a running total of fiber by weight that has run through the Voyager. This reading is not resettable.
- ✦ **Batch** – displays the amount of fiber by weight that has been processed through the Voyager since the last start. The counter runs from the time you press the **START** button until you press the **STOP** button.
- ✦ **OP** (Output Percent) – displays the percentage of the available output signal that is currently driving the Voyager, provided in tenths (which gives a finer definition than the OP value shown in the fixed display area of the screen). An output greater than 100% will cause a **RATE CONTROL FAULT**.
- ✦ **GROSS** – displays the gross weight of fiber currently in the drum.



Note

Even with a completely empty drum, the rate controller may not show zero gross weight; it should typically read within +/-2 lb of zero. Do not attempt to zero the weight display - this will negate the calibration.

- **Function labels** – name of the functions currently assigned to each of the function keys. For more information on the various functions, refer to “[Function keys](#)” on [page 22](#).
- **Status indicator** – indicates the current state of the system: **Idle, Auto, Refill**
- **Fixed area** – displays the output percent (OP) rounded to a whole number, and the current setpoint (SP) for the rate of change. This portion of the screen can not be modified by the user.

Function keys

The functions associated with each of the four function keys (2, [Figure 6](#)) change depending on the current menu and the status of the system. The current function assigned to each key is indicated by the label above the key. The various functions are:

- **MODE** – enables the operator to toggle through the four values of the Summary display.
- **EXIT** – allows you to return to the previous menu.
- **CLR** – appears when you enter a menu. It clears the current value and repositions the cursor for the first entry. To avoid mistakes, you can clear the existing value before entering the new value.
- **START – DO NOT USE** – this function is superseded by the **START** button on the main control panel. If this button is pressed accidentally, press the **STOP** function key.

- **MAN** (Manual) – DO NOT USE – if this button is pressed accidentally, press it again so that **MAN** appears again, which indicates that the system is in **AUTO** mode.
- **HOLD** – DO NOT USE – this function is superseded by the **PAUSE** button on the main control panel.
- **STOP** – DO NOT USE – this function is superseded by the **STOP** button on the main control panel.

Set the feed rate

The controller's rate setpoint must be set to the desired feed rate for the current job. If your Voyager system is equipped with the wireless remote control system, then the rate setpoint is set through the potentiometer on the remote control panel. Refer to "[Wireless remote control system](#)" on [page 17](#), in particular see "[FEEDRATE ADJUSTMENT potentiometer](#):" in [Table 6](#) on [page 18](#).

If your Voyager system is not equipped with the wireless remote control system, then the rate setpoint is set through the rate controller. To change the rate setpoint, perform the following:

1. Press the **Enter** key to enter the Configuration menu.
2. Press the **Down arrow** key until the pointer is at 'Rate Setpoint'.
3. Press the **Enter** key. The Rate Setpoint sub-menu appears.
4. A flashing cursor (see [Figure 8](#)) should be under the right-most digit. The flashing cursor indicates that the digit is active and its value can be changed.



Note

Pressing the CLR function key while in the Rate Setpoint sub-menu will completely clear the existing setpoint. To avoid mistakes, you can clear the existing setpoint before entering the new setpoint.

5. Use the **Up arrow** and **Down arrow** keys to increase and decrease the value of the active digit.
6. Move the flashing cursor from one digit to another by pressing the **Left arrow** and **Right arrow** keys.
7. Once all digits have been adjusted as desired, press the **Enter** key to save the setpoint. The controller will briefly display an "entry accepted" message to confirm that the new rate setpoint has been saved. Exit the configuration menu by pressing the **EXIT** function key.

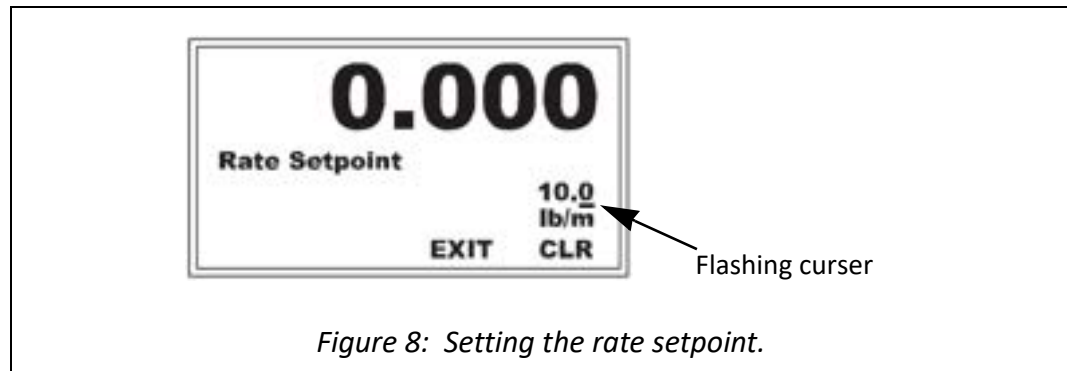

Faults/alarms

Fault conditions are shown on the summary area of the display, but fault handling is done by the fault display on the main control panel; see [“Faults and alarms”](#) on [page 32](#).

Data storage

Continuous feed models are equipped with a Micro SD card for data storage. The card is located inside the main control panel in a drive on the PLC base module. The system records the following data to a “.csv” file every 30 seconds while power is supplied to the system:

- Column 1: Date and time stamp
- Column 2: Actual feed rate (lb/min) x 10*
- Column 3: Weight of fiber in the drum (net weight) (lb) x 10*

Occasionally the system will start a new “.csv” file, so there may be more than one file located on the Micro SD card.

*These values are multiplied by 10 before being recorded to provide better resolution.

Accessing the Micro SD card

To access the micro SD card:

1. Turn off the disconnect switch on the main control panel.
2. Open the door of the main control panel.
3. Identify the location of the PLC base module and the micro SD card drive, see [Figure 9](#).
4. Use a small screwdriver to gently pull the SD card drive housing out of the base module, as shown in [Figure 9](#). This will allow you to access the SD card from the left side of the housing, see [Figure 9](#).
5. Use a small screwdriver to gently push in on the micro SD card and then release it, so that it ‘clicks’ and ejects itself from the housing. Carefully pull the card from the housing.
6. A micro SD card adapter is supplied with the system and can be found taped to the inside of the main control panel. Use the adapter to insert the micro SD card into your computer, and then transfer the “.csv” file from the card to your computer.
7. Once file transfer is complete, remove the adapter from the computer and then the card from the adapter.
8. Reinstall the micro SD card into the housing. Make sure the card is inserted upside down, with the copper contacts facing up. Gently push the card in until you feel a click.



CAUTION!

It is very easy to damage the micro SD card housing when reinserting it into the PLC base module. The housing has 10 small pins which can be easily bent if they are not properly aligned with the sockets in the base module. If all pins are not properly seated in



Chapter 3: Controls and Electronics

their sockets, the card will not record data.

9. Before pushing the housing back into the PLC base module, be sure that it is aligned and straight. Gently push the housing in until you feel a slight resistance. Gently wiggle the housing side-to-side and up-and-down until you feel the pins line up with the pin sockets. Continue to gently push the housing into the module.

Evaluating the data

Before evaluating data in the file, remember to divide the values in both Column 2 and Column 3 by 10 to get the true feed rate and net fiber weight.

Data is recorded even when the Voyager is not running - as long as the system has power it is recording data. When the Voyager is not running, the value recorded for actual feed rate (Column 2) will be "0.1". This is normal and can not be changed.

If you wish to use the data to determine the amount of fiber fed during a run, it is necessary to manually track/record how much fiber is added to the drum during the run, and then the amount of fiber fed can be calculated as follows:

starting weight + total weight added to drum - ending weight

OR

(starting weight - ending weight) + total weight added to drum

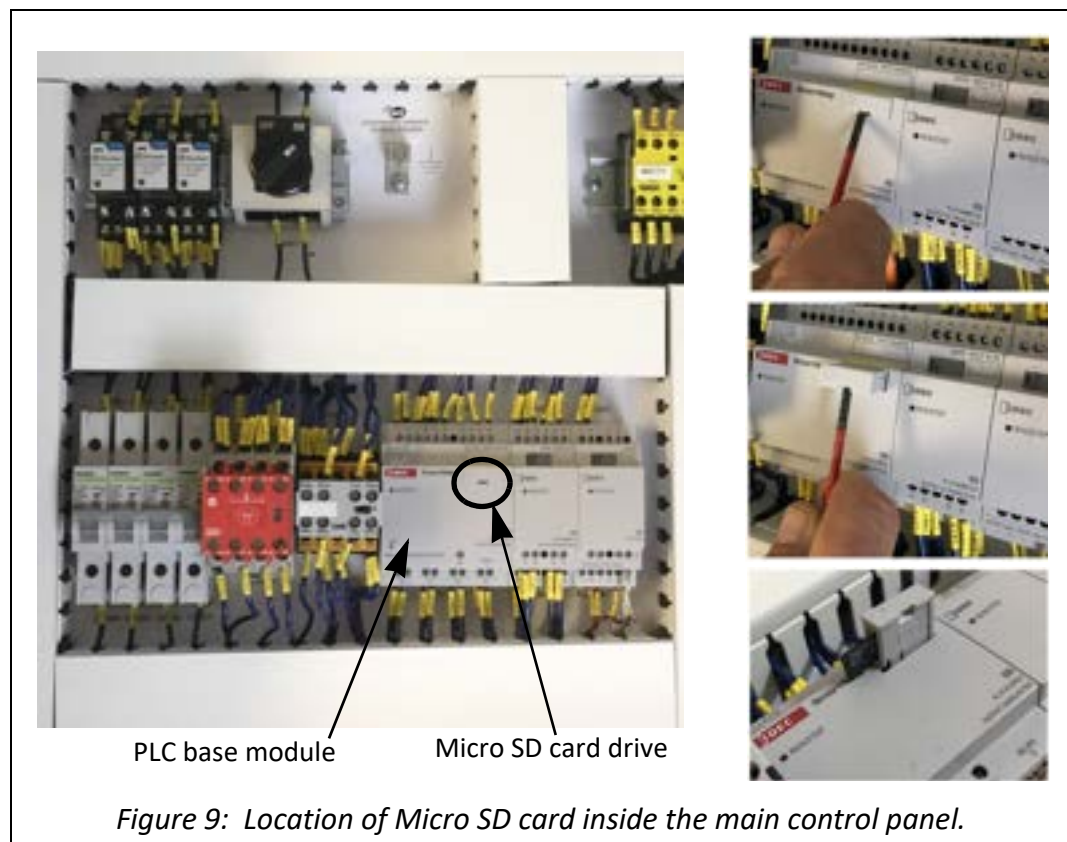

Chapter 4

Operation

Prepare for operation

Before operating the Voyager dispenser, ensure the following:

- For mobile systems, ensure that the trailer has been set up and prepared according to the separately supplied [“Quick Guide - Prepare Mobile System for Operation”](#).
- For stationary systems, ensure that the system has been installed according to the separately supplied [“Quick Guide - Installation for Fixed Operation”](#).
- Ensure that the disconnect for the customer’s power supply is turned ON.
- For mobile systems, ensure that the disconnect on the trailer’s electrical disconnect enclosure is turned ON.
- For systems that include the wireless remote control system, be sure that the remote control panel is located with the other process controls and that it is plugged in.
- Ensure that there are no foreign objects in the drum.
- Ensure that there is nothing binding any of the load cells, the drum or any other part of the Voyager. **Nothing** should be draped over any load cell or the drum - this includes hoses, wires, tubes, loose articles of clothing, etc.

Optimum performance

For optimum performance of the Voyager, the drum should be between 50% and 100% full throughout the duration of a dispensing job. This is due to the changing gravimetric pressure of the fibers in the drum as they are dispensed, and the effect that this has on the feed rate. As the amount of fiber in the drum decreases, the feed rate also decreases. This change is fairly linear until the drum is less than 60% full.

The **LOW FIBER** alarm will trip when the drum is approximately 55% full*. The system will continue to operate until the rate controller senses that the drum is about 25% full*, at which point it will automatically shut down the Voyager. To avoid shutdown and interruption of the job, it is imperative to add fiber to the drum as soon as the **LOW FIBER** alarm is tripped.

*Refer to [Table 3](#) on [page 9](#) for fiber-specific weight information for each of these set-points.

Prime the rake



Important

This procedure is only necessary after filling an empty drum or before a mobile system is operated for the first time after it has been moved with fibers in the drum.

As an **empty** drum is filled with fiber, or as a **non-empty** drum is transported (mobile system), fibers fall into the rake opening. This can cause the rake to bind when it is first turned on. It is necessary to remove those fibers before startup. This is done by priming the rake. Perform the following procedure.

Equipment needed

- Lock-out/tag-out equipment
- Flat head screw driver

Recommended procedure

1. Fill the drum with the fibers that will be used for the job.
2. Put system in **TEST** mode:
 - a. Turn the disconnect switch on the main control panel to OFF.
 - b. Lock-out the disconnect switch (see [Figure 10](#)).
 - c. Use a screw driver to open the door of the main control panel.



Figure 10: Locking-out the disconnect on the main control panel.

- d. Remove the key that is taped to the floor of the box.
- e. Close the door and secure it closed with the screw driver.
- f. Put key in the **RUN/TEST** key switch on the control panel and turn key to **TEST** position.
- g. Remove the lock-out from the disconnect switch and turn the disconnect switch to ON.
- h. Confirm that the display on the control panel indicates that the system is in Manual mode (see Figure 11).



Figure 11: System in Manual control mode.

3. Press the **EMERGENCY STOP** button.
4. Manually rotate the rake coupler (see Figure 12) back and forth to dislodge fibers from the rake. The fibers will fall through the funnel and into the opening of the blower. Rotate the rake coupler until no more fibers fall.

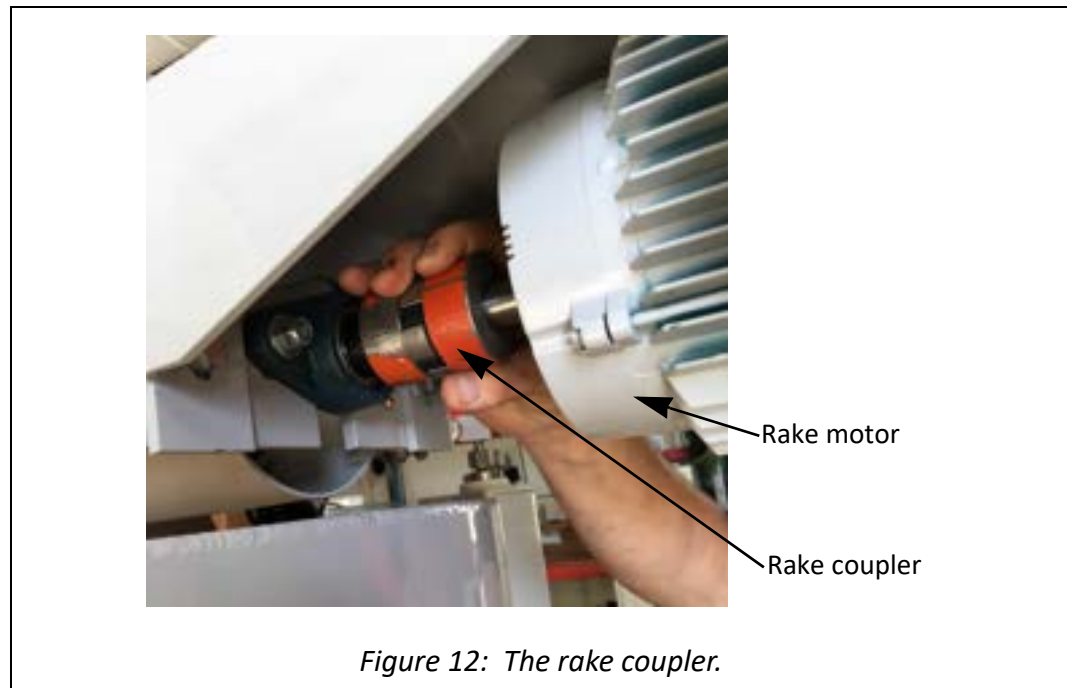

5. Release the **EMERGENCY STOP** button.
6. Press the **BLOWER** button to briefly run the blower and clear it of fibers.
7. Repeat steps 3 through 6 until the rake coupler spins freely by hand and no fibers fall from the rake. This means that the fibers have bridged over the opening above the rake and will no longer fall into the rake.
8. Put system in *RUN* mode:
 - a. Turn the disconnect switch on the main control panel to OFF.
 - b. Lock-out the disconnect switch (see [Figure 10](#)).
 - c. Turn the key to **RUN** and remove it from the **RUN/TEST** key switch.
 - d. Use screw driver to open the door of the main control panel and return the key to its position inside the control panel. Close the door and secure it closed.
 - e. Remove the lock-out from the disconnect switch and turn the disconnect switch to ON.
 - f. Confirm that the fault display on the main control panel no longer indicates that the system is in Manual mode.
9. The system is now ready to operate.

Running a continuous job

Following is the recommended procedure to feed fibers into a continuous asphalt process.

1. Fill the drum with the fibers that will be used for the job. If filling an empty drum or running the first job after the trailer was transported (mobile system), follow the procedure “[Prime the rake](#)” on [page 28](#).
2. Make sure there is an appropriate supply of additional fibers on hand to complete the job.
3. Turn the disconnect on the main control panel to ON.
4. Check that the system status on the rate controller shows *Idle*.
5. Check that the rate controller’s rate setpoint is set at the desired feed rate for the job. Change the feed rate if necessary; see “[Set the feed rate](#)” on [page 23](#).



Note

If the system is equipped with the wireless remote control system, the feed rate can only be set at the remote control panel.

6. When you are ready to introduce fibers into the asphalt process, press the **START** button on the main control panel (or on the wireless remote control panel when equipped). The blower immediately turns on, and then 5 seconds later the drum and rake turn on to feed fibers to the blower. At this point the rate controller takes over control of the system.



Note

It is recommended that the Summary display be set to show GROSS, so that the current weight of fiber in the drum can be easily monitored during the job.

7. Add fibers to the drum as necessary throughout the job using the **FILL** mode; see “[Filling the drum during a continuous job](#)” on [page 31](#).

Filling the drum during a continuous job

When it is necessary to add fiber to the drum while the Voyager dispenser is feeding fiber, you must put the system in **FILL** mode. When in **FILL** mode, the rate controller switches from running the system in rate control to running at a fixed speed and shows a status of **Refill**.



CAUTION!

*Do NOT add fiber to the drum if the system is not in **FILL** mode - this will cause a RATE CONTROL FAULT which will shut down the system.*

1. Put the system in **FILL** mode by pressing the **FILL** button on the main control panel. Both the **FILL** and **STOP** buttons illuminate to indicate that the system is in **FILL** mode, also the status on the rate controller will switch to **Refill**.

Chapter 4: Operation

2. Add fibers to the drum until drum is full. Be careful not to inhibit rotation of the drum while adding fiber.



Note

*If the amount of fibers in the drum reaches maximum capacity while filling (see [Table 3 on page 9](#)), the system will automatically exit **FILL** mode and return to normal operation.*

3. Make sure that nothing is hanging on or draped over the drum.
4. If the **FILL** mode does not shut off automatically, take the system out of **FILL** mode by pressing the **FILL** button; the rate controller will switch back to running the system in rate control. Do not allow the system to remain in **FILL** mode for an excessive amount of time after completing the addition of fiber.

Faults and alarms

If the Voyager stops unexpectedly during a job, check the fault display screen on the main control panel for a fault condition. There are 6 fault conditions that will cause the Voyager to shutdown:

- E-STOP FAULT
- RATE CONTROL FAULT
- FUNNEL CLOGGED FAULT
- RAKE MOTOR FAULT
- BLOWER MOTOR FAULT
- DRUM MOTOR VFD FAULT

A fault condition will also cause the signal horn and strobe light to turn on. Refer to “[Troubleshooting](#)” on [page 33](#) for more information on each fault.

During normal operation, the display should read *NO FAULTS*.

Operating tips

- If wind is an issue in situations where fiber is being output onto a belt, add a water injection system to mist the fibers after they are on the belt.
- During operation, periodically check the exit end of the discharge tube for buildup of fibers and other materials. Buildup can quickly lead to a blockage in the tubing which will lead to a fault/system shutdown. Remove all buildup.

Troubleshooting

In the event that problems arise during operation of the system, refer to [Table 7](#) for help in determining the specific problem and its solution. If the problem cannot be determined through the chart, contact FORTA® Corporation as directed on [page 7](#).

Table 7: Troubleshooting the system.

1	Indication: The Voyager has shutdown and the fault display on the main control panel indicates an <i>E-STOP FAULT</i> .	
	Problem	Solution
	The EMERGENCY STOP button has been pressed.	To clear the fault, resolve whatever issue caused the operator to press the EMERGENCY STOP button and then release the button by turning it clockwise as depicted by the arrows on the knob face; the button should then pop out.
2	Indication: The Voyager has shutdown and the fault display on the main control panel indicates a <i>RATE CONTROL FAULT</i> .	
	Problem	Solution
	<p>The rate controller is unable to maintain the feed rate. This could be caused by:</p> <ul style="list-style-type: none"> • The feed rate is set too high for the fiber being dispensed. • The fiber level in the drum is too low. • The weight of the drum can not be measured accurately. • Rake is bound. • A load cell or load cell cable is damaged. 	<p>To clear the fault, press the STOP button on the main control panel. Determine and correct the reason for the fault; check the following:</p> <ul style="list-style-type: none"> • Check the feed rate setting and make adjustments as necessary; see “Set the feed rate” on page 23. • Check the fiber level and add fiber as necessary. • Check that there is nothing wedged between the floor and base/drum and that there are no foreign objects between the stand and base. Check that the load cells are adjusted to sufficient height so that the rake housing is not in contact the stand. Check that the discharge chute is not in contact with the funnel; an air gap must be maintained between them. • Prime the rake; see page 28. During the procedure, pay attention for the possibility of a foreign object lodged in the rake. • If none of the above correct the issue and the fault persists, there could be a damaged load cell or cable. Contact FORTA® Corporation as directed on page 7.

Chapter 4: Operation

Table 7: Troubleshooting the system. (Continued)

3	Indication: The Voyager has shutdown and the fault display on the main control panel indicates a <i>RAKE MOTOR FAULT</i> .	
	Problem	Solution
	<p>The circuit breaker for the rake motor has tripped due to the rake getting bound by fibers or foreign material. This can be caused by:</p> <ul style="list-style-type: none"> • The feed rate is set too high for the fiber being dispensed. • The rake was not primed when needed. • Fibers in the drum have absorbed moisture from the air. 	<ul style="list-style-type: none"> • If the fibers have set overnight (or longer) in the drum, check them for moisture, otherwise continue to the next bullet. Certain fibers can absorb moisture from the air if they sit too long in the drum, this will cause them to swell and potentially clog the rake or discharge tubing. Moisture in the fibers can generally be detected by feel, or by squeezing a handful with a dry cloth. It may be necessary to remove all fibers from the drum and refill the drum with dry fibers. • Prime the rake; see page 28. During the procedure, pay attention for the possibility of a foreign object lodged in the rake. • Check the feed rate setting and make adjustments as necessary; see “Set the feed rate” on page 23. <p>Once any issues have been resolved, perform the procedure under “Rake motor or blower motor fault” on page 39.</p>

Table 7: Troubleshooting the system. (Continued)

4	<p>Indication: The Voyager has shutdown and the fault display on the main control panel displays a <i>BLOWER MOTOR FAULT</i>. The fault display could also indicate a <i>FUNNEL CLOGGED FAULT</i>.</p>	
	<p>Problem</p>	<p>Solution</p>
	<p>The circuit breaker for the blower motor has tripped due to the blower getting plugged with fibers or foreign material:</p> <ul style="list-style-type: none"> • This is usually caused by blockage somewhere between the funnel and the exit point of the discharge tubing. • It can also be caused by the feed rate set too high for the fiber being dispensed. 	<p>It is very important to locate and clear all blockages. Do not force the Voyager to operate without clearing blockages - doing so will completely clog the blower which is very difficult to clear.</p> <ul style="list-style-type: none"> • Check that there is a finger-size air gap between the discharge chute of the drum and the funnel of the blower. The gap should be all the way around the chute/funnel. Also, if there is fiber coming out of this gap, this indicates a definite blockage further down the tubing. • Check for blockage at the edges of the rake housing. • Check entire length of discharge tube, in particular the exit point, for fiber build up, and clear it. • If blockage is severe, clear the blower of any fiber buildup by performing steps 2, 6, and 8 of “Prime the rake” on page 28. <p>To prevent future blockage:</p> <ul style="list-style-type: none"> • Ensure that fiber is DRY. • Ensure that tubing is static-resistant tubing (see the separately supplied “Quick Guide - Prepare Mobile System for Operation” or “Quick Guide - Installation for Fixed Operation”). • Periodically clear any buildup on the exit point of the tubing. <p>If the fault persists but the system appears to be functioning correctly, contact FORTA® Corporation as directed on page 7.</p> <p>Once any issues have been resolved, perform the procedure under “Rake motor or blower motor fault” on page 39.</p>

Chapter 4: Operation

Table 7: Troubleshooting the system. (Continued)

5	Indication: The Voyager has shutdown and the fault display on the main control panel indicates a <i>FUNNEL CLOGGED FAULT</i> .	
	Problem	Solution
	<p>The through-beam sensor in the funnel has detected insufficient movement of fiber through the funnel:</p> <ul style="list-style-type: none"> • This is usually caused by blockage somewhere between the funnel and the exit point of the discharge tubing. • It can also be caused by the feed rate set too high for the fiber being dispensed. 	<p>Refer to the solutions outlined under problem number 4 (<i>BLOWER MOTOR FAULT</i>).</p> <p>If the indication was a <i>FUNNEL CLOGGED FAULT</i> only, then it is NOT necessary to perform the procedure under “Rake motor or blower motor fault” on page 39.</p>
6	Indication: The Voyager has shutdown and the fault display on the main control panel indicates a <i>DRUM MOTOR VFD FAULT</i> .	
	Problem	Solution
	<p>The system has been shut off suddenly or there has been a sudden change in voltage.</p>	<p>Perform the procedure under “Drum motor VFD fault” on page 41. If the fault persists, contact FORTA® Corporation as directed on page 7.</p>

Chapter 5

Maintenance

Recommended maintenance schedule

The Voyager system will require very little maintenance or repair if the system is kept clean. The frequency of cleaning the system is very dependent on the conditions in which the system is used; the frequency for a system that is used in a fairly clean environment will be less often than that of a system used in a dirty environment. Refer to the recommended maintenance schedule in [Table 8](#).

Table 8: Recommended maintenance schedule.

Frequency	Maintenance Item
Multiple times a day ¹	<ul style="list-style-type: none"> Check the exit end of the discharge tubing for buildup. Remove all buildup.
Daily ¹	<ul style="list-style-type: none"> Remove any loose fiber and other debris from the fan shroud of the rake motor, drum motor, and blower. Remove any loose fiber and other debris from the drum's belt, bearings, and guides.
Dependent on duty cycle of the system ²	<ul style="list-style-type: none"> Inspect the drum belt; see page 38. Lubricate the rake bearings; see page 38. Inspect the rake coupler insert (spider); see page 39.
Annually ³	<ul style="list-style-type: none"> Calibrate the system; see page 42.

- Frequency is very dependent on the conditions in which the system is used; the frequency for a system used in a fairly clean environment will be less often than a system used in a dirty environment. We recommend that you use the frequency listed as a starting point and then adjust as experience dictates.
- If the system is used at a duty cycle of 75% (for example, system is operating a total of 6 hours out of every 8), the recommended frequency is every 2-4 weeks. If the system is used at a duty cycle between 75%-25%, the recommended frequency is monthly. If the system is used at a duty cycle less than 25%, the recommended frequency is biannually or twice per operating season, whichever is more frequent.
- Annually or as determined by any calibration schedule of existing weighing scales in your facility.

Inspect the drum belt

The drum belt should be inspected at the frequency stated in [Table 8](#) on [page 37](#). Inspect the teeth of the belt for wear and damage. Any wear or damage that causes the drum to slip during operation would require that the belt be replaced; contact FORTA® Corporation as directed on [page 7](#).

Lubricate the rake bearings

The rake shaft is supported by two bearings - one on each end of the shaft. Both bearings should be lubricated at the frequency stated in [Table 8](#) on [page 37](#). Each bearing is equipped with a grease fitting (see [Figure 13](#)). Use a general purpose grease. Follow proper lock-out/tag-out procedures to lock-out the main control panel before performing maintenance.

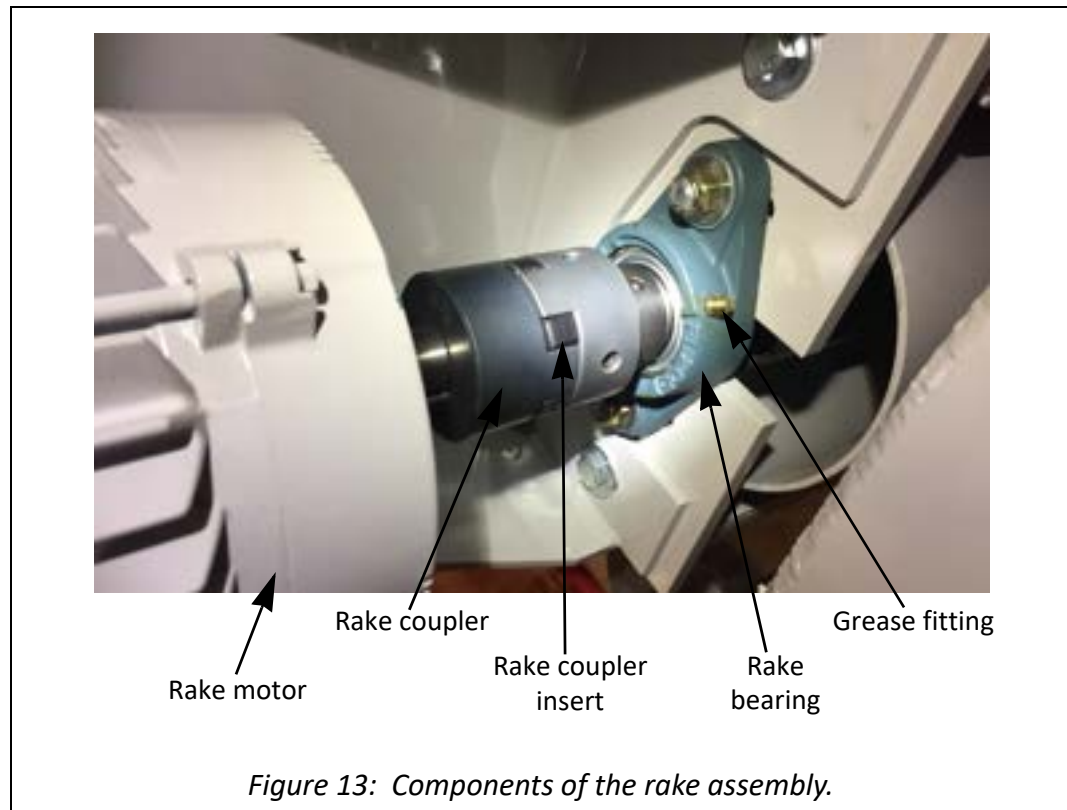

Inspect the rake coupler insert (spider)

The rake coupler should be inspected for wear of the rake coupler insert at the frequency stated in [Table 8](#) on [page 37](#). Wear of the rake coupler insert would cause play or slop between the two halves of the coupler (see [Figure 13](#)). Ideally, there would be no play between the two halves of the coupler. If play is noticeable, the insert should be replaced, contact FORTA® Corporation as directed on [page 7](#). A new insert can be purchased before a service visit; the proper part can be ordered from Lovejoy, Inc., part number 68514410968 (a Buna N spider for a #L095 3-jaw coupler).

Circuit protection

The system's electrical circuits are protected by various circuit breakers and fuses.

- There are three (3) 15 A mains fuses (see [Figure 15](#) on [page 40](#)). These fuses should only require replacement if there has been a hard short to ground. In the unlikely event that one or more of the mains fuses have blown, the Voyager must be immediately taken out of service and disconnected from the 480V electrical supply. Do not replace these fuses without consulting with FORTA® Corporation; contact FORTA® Corporation as directed on [page 7](#).
- Each motor in the system is protected from overload by a circuit breaker (see [Figure 15](#) on [page 40](#)). If one or more of these circuit breakers is tripped during operation, the Voyager system is stopped and the fault display on the main control panel will indicate the appropriate fault(s). To reset the system when a motor fault occurs, perform the appropriate procedure below.

Reset system after a motor fault

Rake motor or blower motor fault

To reset the system after a **RAKE MOTOR FAULT** or a **BLOWER MOTOR FAULT**, you must determine and correct any issues that caused the fault, and then reset the tripped overload circuit breaker. Perform the following procedure.

1. Use appropriate lock-out/tag-out procedures to lock-out the electrical supply mains for the system (for mobile systems this would be the electrical disconnect enclosure on the outside of the trailer, or for stationary systems this would be the facility's supply); see [Figure 14](#).

Chapter 5: Maintenance



Figure 14: Lock-out/tag-out of the electrical disconnect enclosure (mobile system).

2. Determine and correct any issues that caused the fault; refer to “Troubleshooting” on page 33.
3. Ensure that the mains supply for the system is still locked-out.
4. Open the main control panel and reset any overload circuit breakers that are tripped; see Figure 15.

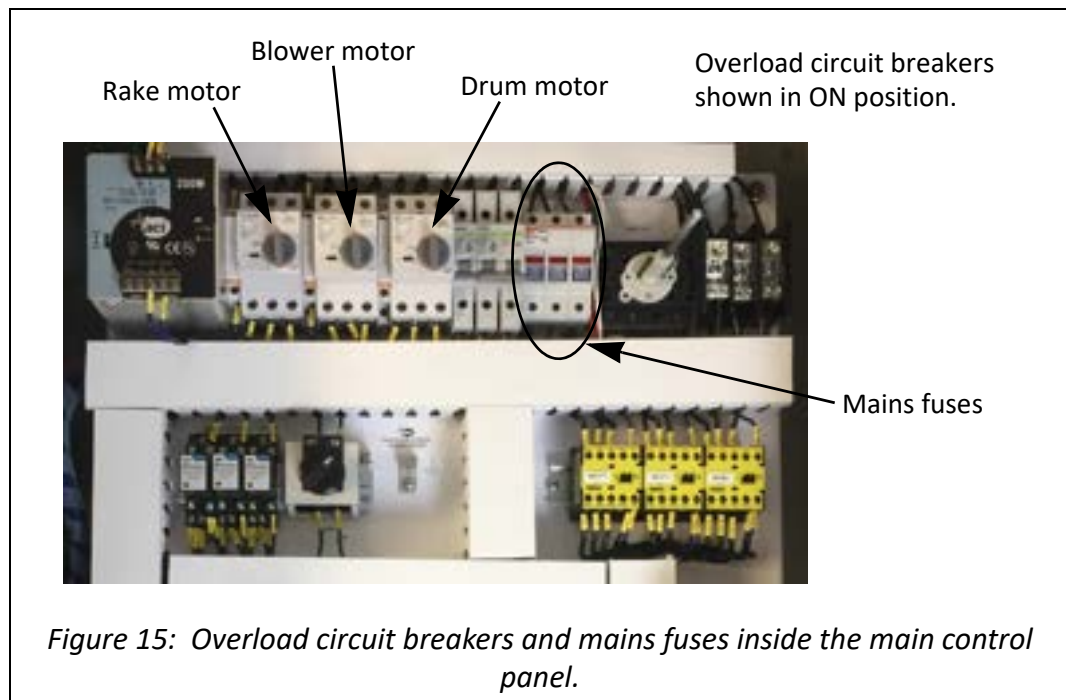

Figure 15: Overload circuit breakers and mains fuses inside the main control panel.

5. Close the main control panel.
6. Remove the lock-out from the system’s electrical supply mains.
7. Restore power to the system and continue operation.

Drum motor VFD fault

To reset the system after a **DRUM MOTOR VFD FAULT**, you must determine and correct any issues that caused the fault, and then reset the motor driver. Perform the following procedure.

1. Turn the disconnect switch on the main control panel to OFF for at least 2 seconds, and then turn the disconnect switch back ON.
2. The VFD unit will power up after a few seconds and will beep. The **DRUM MOTOR VFD FAULT** should clear from the display. If the fault did not clear from the display, repeat step 1. If the fault still does not clear go to the next step. If the fault clears, continue operation.
3. Use appropriate lock-out/tag-out procedures to lock-out the electrical supply mains for the system (for mobile systems this would be the electrical disconnect enclosure on the outside of the trailer, or for stationary systems this would be the facility's supply); see [Figure 14](#).
4. Open the main control panel and check if the drum motor overload circuit breaker is tripped; see [Figure 15](#). If the circuit breaker is tripped, reset it and continue with step 5. If the circuit breaker is not tripped, contact FORTA® Corporation as directed on [page 7](#).
5. Close the main control panel.
6. Remove the lock-out from the system's electrical supply mains.
7. Restore power to the system and continue operation.
8. If the fault persists, contact FORTA® Corporation as directed on [page 7](#).

Calibrate the system

The weighing system on each Voyager is calibrated at the factory before shipment. Weighing systems should be re-calibrated as stated in “[Recommended maintenance schedule](#)” on [page 37](#). Refer to the following sections for instructions on how to calibrate the weighing system on your Voyager; be sure to refer to the correct model for your system - continuous feed or batch feed.

Continuous feed model

Traditional calibration of a weighing system uses certified test weights. Our electronic calibration allows the Voyager’s weighing system to be calibrated without the need for test weights. Calibration can be performed by the customer (see the [Recommended procedure](#) below). The Voyager’s weighing system consists of four load cells, a junction box, interconnect cables, and the rate controller. Each individual load cell’s characteristics (sensitivity values) are measured on National Institute of Standards and Technology (NIST) traceable test devices and electronically recorded on an internal memory device when the load cell is manufactured. Each load cell’s sensitivity value is accurate to five significant digits. The electronic calibration system uses these parameters, the load cells’ characteristics and a reference point (0,0) to calibrate the weighing system.

On startup, the rate controller polls the load cell network and compares the load cell serial numbers to check if there were any hardware changes since the last calibration. If the system detects an issue with one or more of the load cells at any time, it will indicate a **RATE CONTROL FAULT**.

Recommended procedure

1. Ensure that the Voyager’s drum is **completely** empty and that there is nothing binding any of the load cells, the drum or any other part of the Voyager. **Nothing** should be draped over any load cell or the drum - this includes hoses, wires, tubes, loose articles of clothing, etc.
2. Ensure that all load cells are adjusted so that they carry about the same weight; this is important. We recommend using the amount of torque required to turn the load cell adjuster as a method of checking each load cell (see [Figure 16](#)). A torque wrench is not necessary; this can be done by feel with a regular wrench. Before checking/adjusting each load cell be sure to loosen its lock nut. Re-tighten all lock nuts when adjustments are complete.

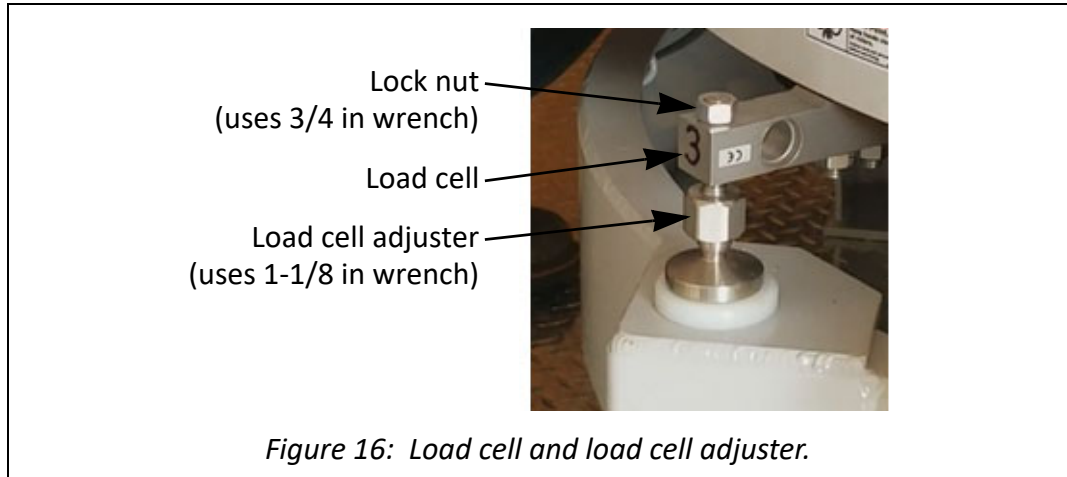

3. On the rate controller, press the **Enter** key once (see [Figure 17](#)) to enter the Configuration menu.

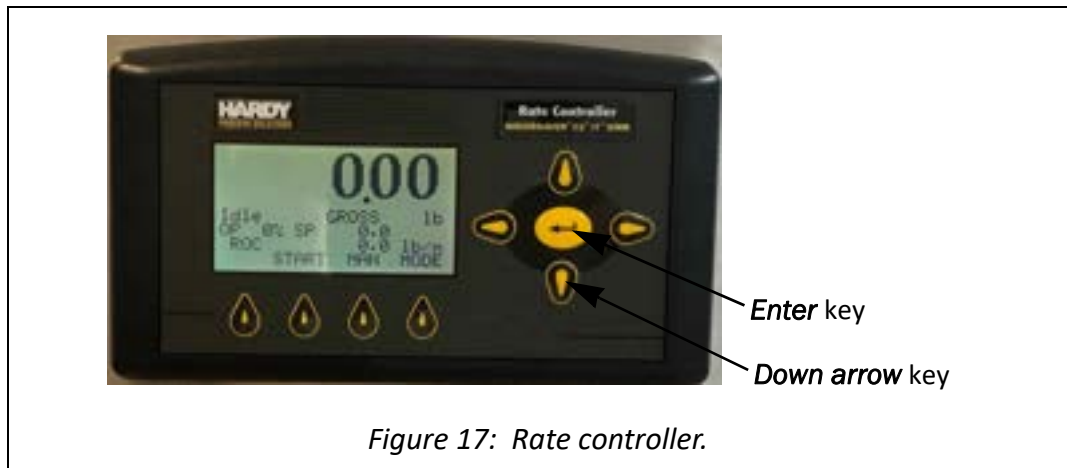

4. Press the **Down arrow** key until the pointer is at 'Scale Calibration' (typically press the key 8 times); see [Figure 18](#).



Chapter 5: Maintenance

- The display should now allow the operator to select between “C2 Cal” or “Trad Cal”. Ensure that “C2 Cal” is selected as shown in [Figure 19](#), and press the *Enter* key.



- The display arrow should now point to “Num C2 4” as shown in [Figure 20](#). Press the *Enter* key once.

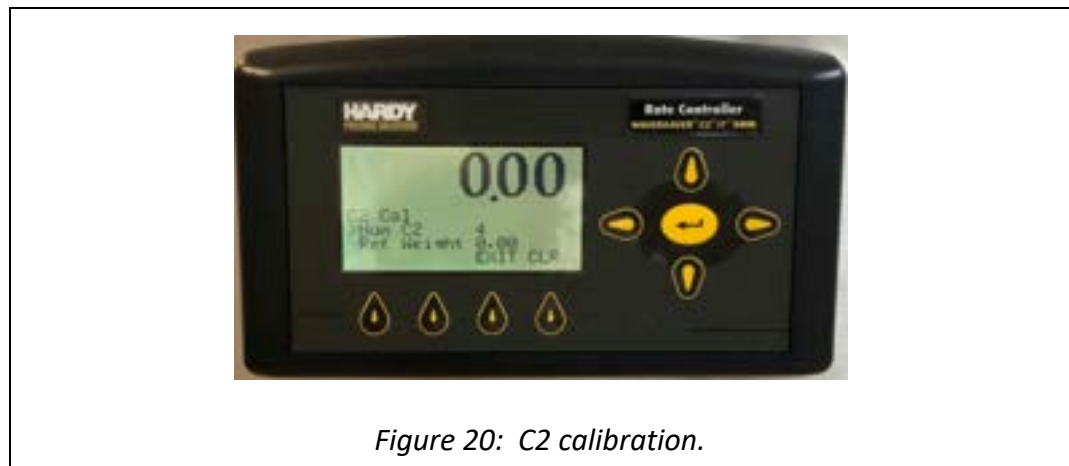

- Press the *Down arrow* key 3 times until the arrow points to “C2 Cal Do Cal” (see [Figure 21](#)).

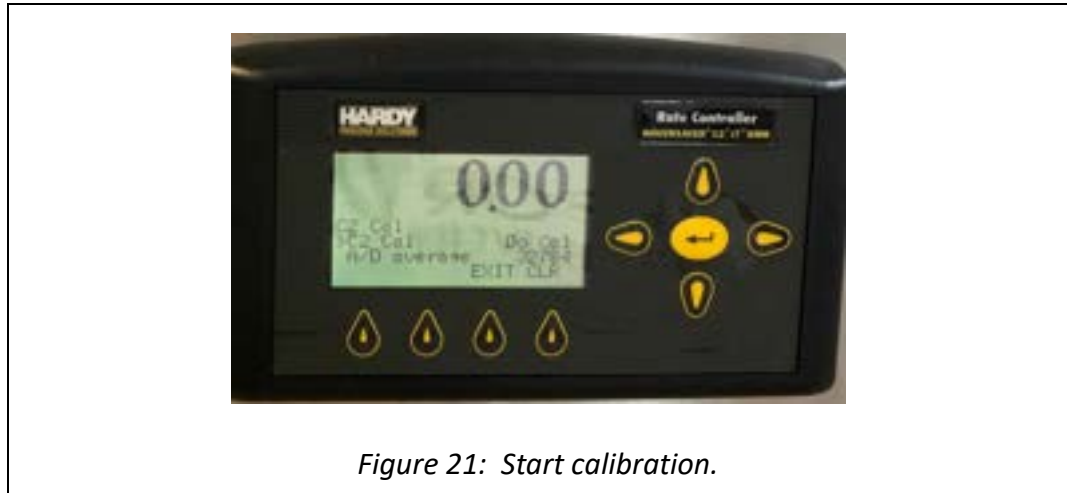

Figure 21: Start calibration.

8. Press the **Enter** key once. The display will read “Cal in progress” and then “Cal completed OK”.
9. Press the **EXIT** function key 3 times to return to the Home screen. The display will show “TST”; this indicates that the calibration is in progress (see [Figure 22](#)). The system is inoperative while calibration is in progress.
10. Calibration is complete once “TST” is gone from the screen.

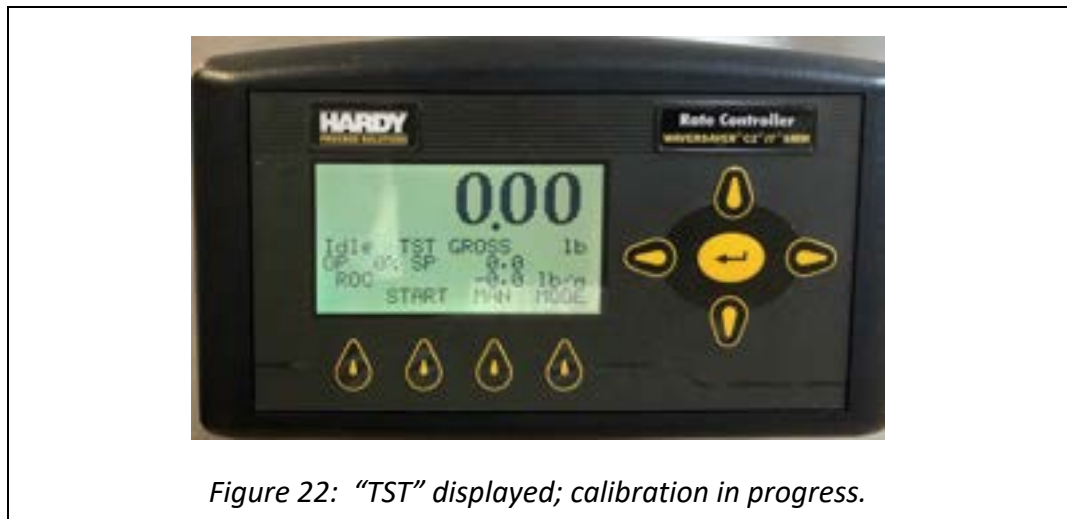

Figure 22: “TST” displayed; calibration in progress.

Chapter 5: Maintenance

Batch feed model

Typically calibration is performed by an accredited scale calibration provider.

Equipment and supplies needed

- Certified test weights totaling 275-325 lb. **Important - see note below.**
- A piece of 3/4 in thick plywood (or similar) that is 4 ft x 4 ft. It must be large enough to fit across the top of the Voyager's drum. It must be accurately weighed to the nearest 1/100th of a pound. **Important - see note below.**
- Adjustable wrench, or a 3/4 in wrench and a 1-1/8 in wrench.



Important

The target combined weight of the certified test weights and plywood should be greater than 300 lb but no more than 375 lb. This combined weight should be known to the nearest 1/100th of a pound and is the "Calibration Test Weight" that will be used in step 9 of the following procedure.

Recommended procedure

1. Ensure that the Voyager's drum is **completely** empty and that there is nothing binding any of the load cells, the drum or any other part of the Voyager. **Nothing** should be draped over any load cell or the drum - this includes hoses, wires, tubes, loose articles of clothing, etc.
2. Ensure that all load cells are adjusted so that they carry about the same weight; this is important. We recommend using the amount of torque required to turn the load cell adjuster as a method of checking each load cell (see [Figure 23](#)). A torque wrench is not necessary; this can be done by feel with a regular wrench. Before checking/adjusting each load cell be sure to loosen its lock nut. Re-tighten all lock nuts when adjustments are complete.

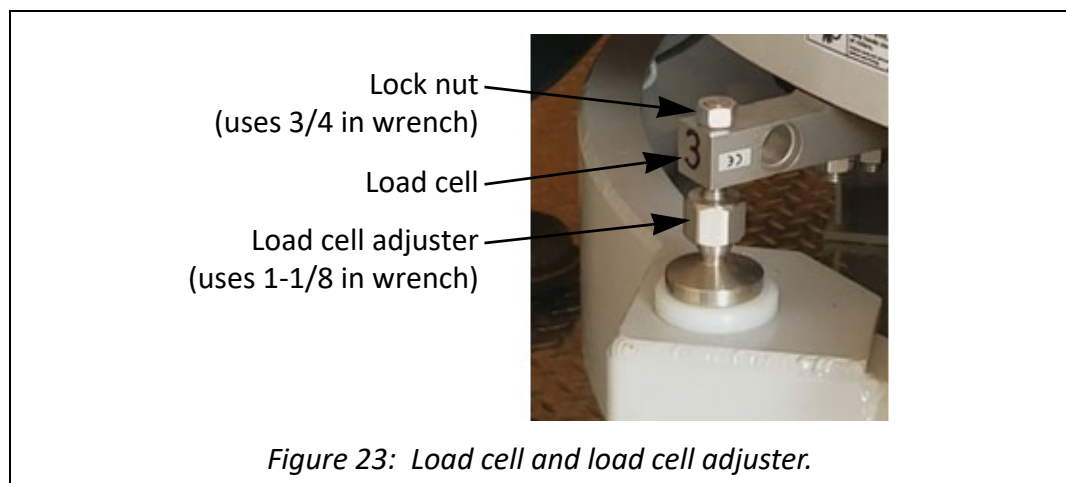

3. Ensure that you have certified test weights and plywood as described in “Equipment and supplies needed” on page 46 and that you know their total combined weight to the nearest 1/100th of a pound.
4. Turn on power to the Voyager.
5. On the process controls, navigate to the Calibration screen:
 - a. From the main display screen, touch the **Set Up Menu** button on the touch screen (see Figure 24).
 - b. On the Setup Screen, touch the **Calibration Setup Screen** box on the touch screen (see Figure 25); a password entry screen will open. Enter the password “1234” on the touch screen and then touch the **Enter** symbol. The Calibration Screen should open (see Figure 26).

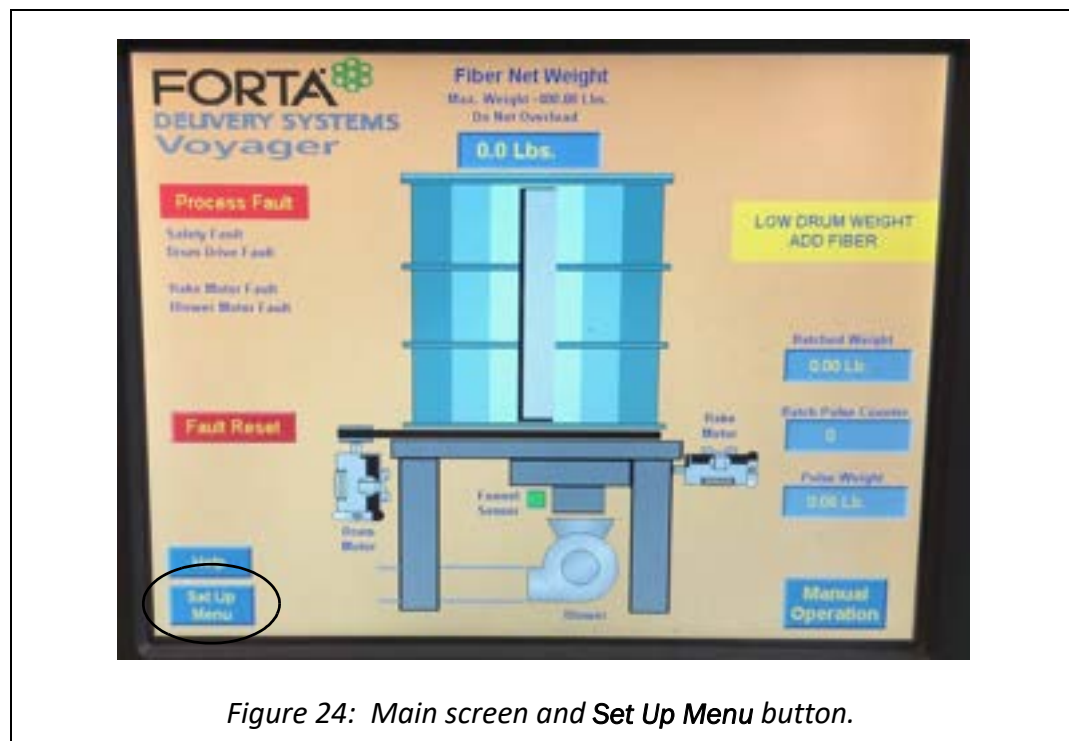

Figure 24: Main screen and Set Up Menu button.

Chapter 5: Maintenance

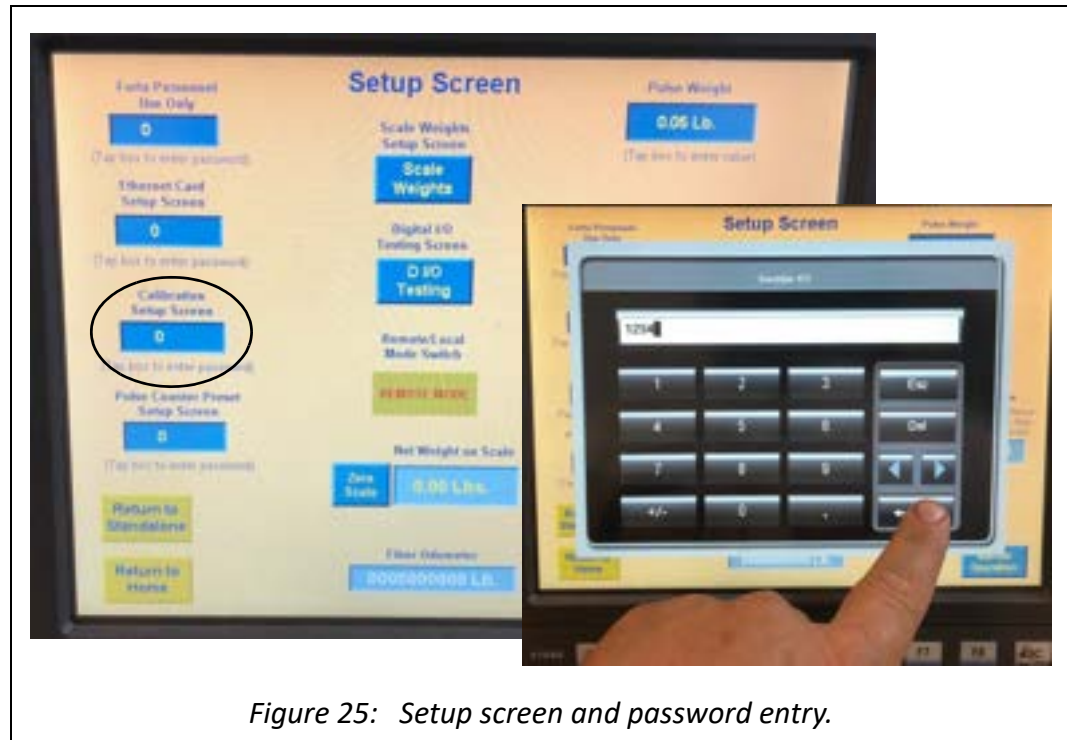

Figure 25: Setup screen and password entry.

6. Before calibration can proceed, the existing calibration data must be cleared; touch the **Clear Calibration** button. A warning message and additional buttons will appear next to the button (see inset of Figure 26). Touch **Yes** to confirm that you want to clear the calibration data.

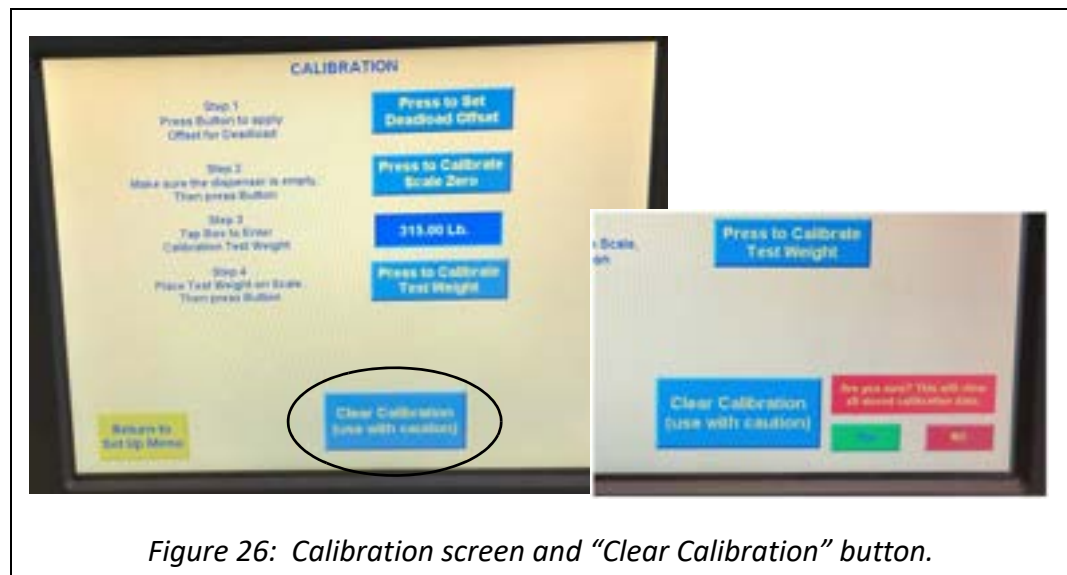
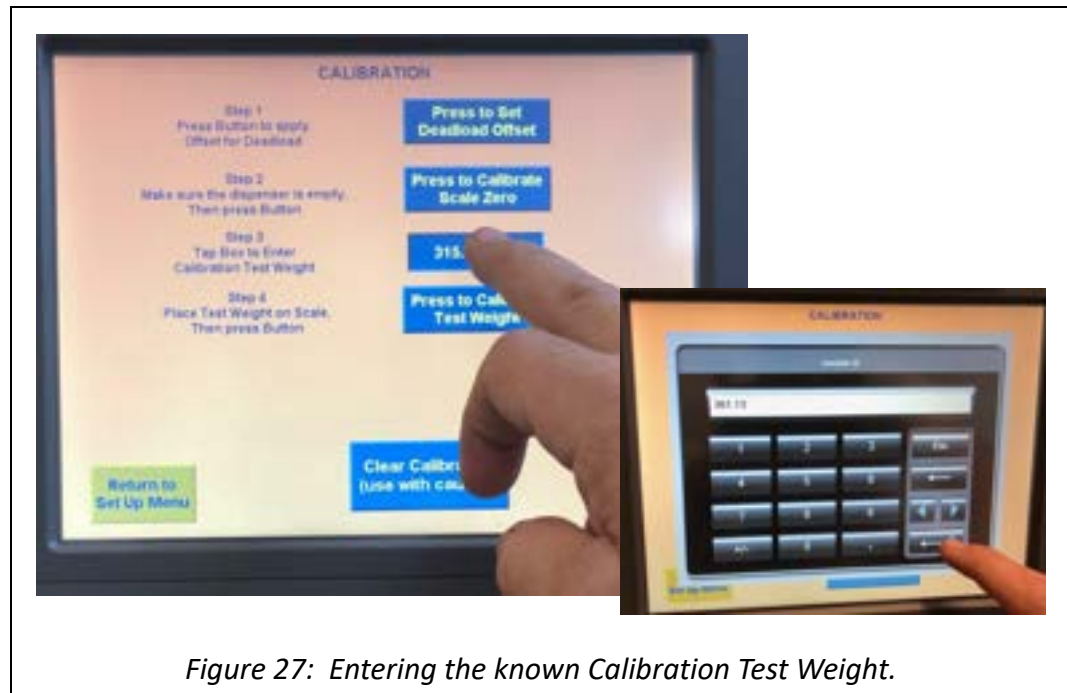

Figure 26: Calibration screen and "Clear Calibration" button.

7. Double check that the drum is completely empty and that nothing is touching the base or drum (refer to step 1 of this procedure). Touch the **Press to Set Deadload Offset** button (Step 1). This helps to compensate for the dead load weight seen by the load cells (which is approximately 365 lb) and allows for a wider dynamic range of readings.

8. Ensure that nothing is touching the base or drum and touch the *Press to Calibrate Scale Zero* button (Step 2).
9. Touch the box for Step 3 and enter the known “Calibration Test Weight” (determined in “[Equipment and supplies needed](#)” on page 46), then touch the *Enter* symbol (see Figure 27).



10. Apply the test weights to the drum:
 - a. Put the piece of plywood across the top of the drum and center it over the opening.
 - b. Put the test weights on the plywood as close to the center of the plywood as possible.
 - c. Ensure that nothing else is touching the base or drum.
11. Touch the *Press to Calibrate Test Weight* button (Step 4).
12. Remove the test weights and plywood from the drum.
13. Touch the *Return to Set Up Menu* button in the bottom left corner of the screen.
14. If the *Net Weight on Scale* field does not read “0.00 Lbs.”, zero it by touching the *Zero Scale* button.
15. Touch the *Return to Home* button to close the Calibration screen.
16. Calibration is complete.

Chapter 5: Maintenance
